



LDS02 – LoRaWAN Door Sensor User Manual

Document Version: 1.3

Image Version: v1.3

Version	Description	Date
1.0	Release	2021-May-16
1.1	Add more Battery Description	2021-Jul-1
1.3	Update LDS02 photo for with new version	2022-Jan-8

1. Introduction	4
1.1 What is LDS02 LoRaWAN Door Sensor	4
1.2 Features	5
1.3 Applications	5
1.4 Dimension	5
1.5 Firmware Change log	5
2. Power ON LDS02	6
3. How to install LDS02	6
4. Operation Mode	7
4.1 How it works?	7
4.2 Example to join LoRaWAN network	7
4.3 Uplink Payload	10
4.4 Downlink Payload	11
4.5 Integrate with Datacake	14
4.6 Alarm Base on Timeout	17
4.7 LEDs	18
5. Battery & How to replace	19
5.1 Battery Type and replace	19
5.2 Battery Life Analyze	19
6. Use AT Command	20
6.1 Access AT Command	20
7. FAQ	21
7.1 How to upgrade the image?	21
7.2 How to change the LoRa Frequency Bands/Region?	21
7.3 Can I disable uplink for each event to save battery life?	21
8. Order Info	22
9. Packing Info	22

10. Support 22

1. Introduction

1.1 What is LDS02 LoRaWAN Door Sensor

The Dragino LDS02 is a LoRaWAN Door Sensor. It detects door open/close status and uplink to IoT server via LoRaWAN network. user can see the door status, open time, open counts in the IoT Server.

LDS02 is powered by 2 x AAA batteries and target for long time use, these two batteries can provide about 16,000 ~ 70,000 uplink packets. After battery running out, user can easily open the enclosure and replace with 2 common AAA batteries.

The LDS02 will send periodically data every day as well as for each door open/close action. It also counts the door open times and calculate last door open duration. User can also disable the uplink for each open/close event, instead, device can count each open event and uplink periodically.

LDS02 has the open alarm feature, user can set this feature so device will send Alarm if the door has been open for a certain time.

Each LDS02 is pre-load with a set of unique keys for LoRaWAN registration, register these keys to LoRaWAN server and it will auto connect after power on.



1.2 Features

- ✓ LoRaWAN Class A v1.0.3
- ✓ Frequency Bands: CN470/EU433/KR920/US915/EU868/AS923/AU915/IN865/RU864
- ✓ SX1262 LoRa Core
- ✓ Door Open/Close detect
- ✓ Door open/close statistics
- ✓ 2 x AAA LR03 Batteries
- ✓ AT Commands to change parameters
- ✓ Uplink on periodically and open/close action
- ✓ Remote configure parameters via LoRa Downlink
- ✓ Firmware upgradable via program port

1.3 Applications

- ✓ Smart Buildings & Home Automation
- ✓ Logistics and Supply Chain Management
- ✓ Smart Metering
- ✓ Smart Agriculture
- ✓ Smart Cities
- ✓ Smart Factory

1.4 Dimension

Unit: mm

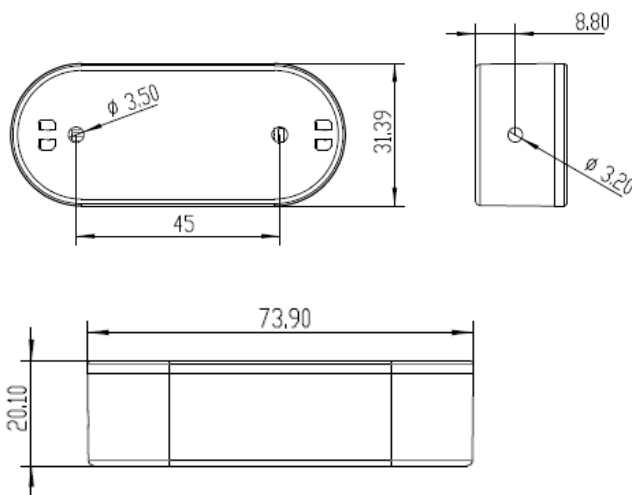

1.5 Firmware Change log

LDS02 use the same firmware as LDS01.

[LDS02 Image files – Download link](#)

2. Power ON LDS02

When receive the LDS02, please open the enclosure and add 2 x AAA batteries to power it. The [LED](#) will blink when device is powered. ✓

3. How to install LDS02

When install the LDS02 on wall. Please make sure install as below so the marks will close to each other when close the door.

Open/Close threshold range: ~ 25mm

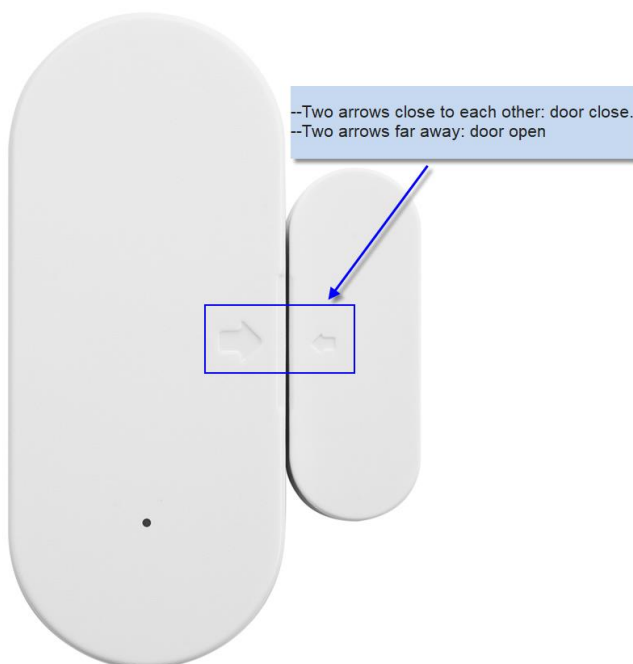

4. Operation Mode

4.1 How it works?

The LDS02 is configured as LoRaWAN OTAA Class A mode by default. It has OTAA keys to join network. To connect a local LoRaWAN network, user just need to input the OTAA keys in the network server and [power on](#) the LDS02. It will auto join the network via OTAA.

In case user can't set the OTAA keys in the network server and has to use the existing keys from server. User can [use AT Command](#) to set the keys in the devices.

Warning!

4.2 Example to join LoRaWAN network

Here shows an example for how to join the [TTN V3 Network](#). Below is the network structure, we use [LG308](#) as LoRaWAN gateway here.



The LDS02 is installed on the door edge to detect the open / close event. And send the status to LoRaWAN server. The LDS02 will uplink two type of messages to the server.

- ✓ [A keep-alive message which send once per day.](#)
- ✓ [A door event message when there is a door open/close.](#) ([Alarm event can be disabled](#))

The LG308 is already set to connect to [TTN V3 network](#). What we need to now is only configure the TTN V3:

Step 1: Create a device in TTN V3 with the OTAA keys from LDS02.

Each LDS02 is shipped with a sticker with unique device EUI:



User can enter this key in their LoRaWAN Server portal. Below is TTN V3 screen shot:
Add APP EUI in the application.

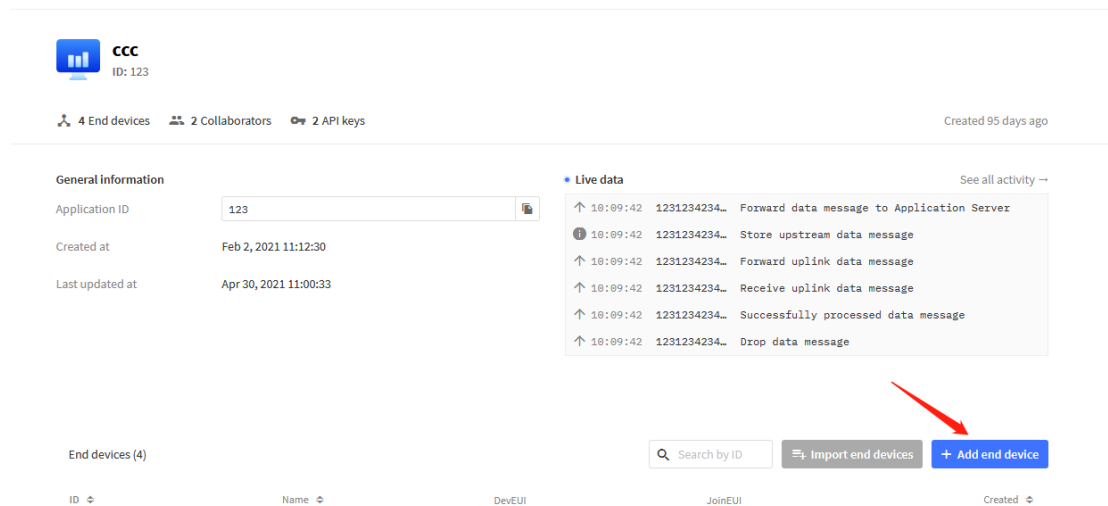
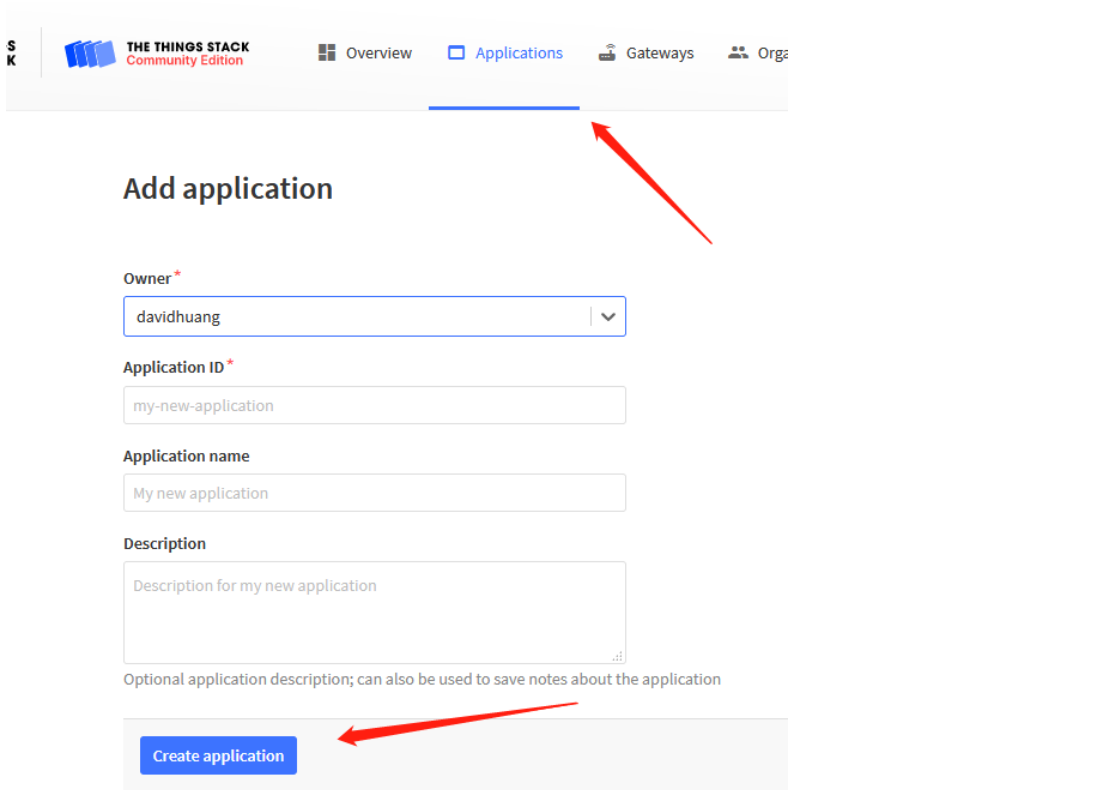

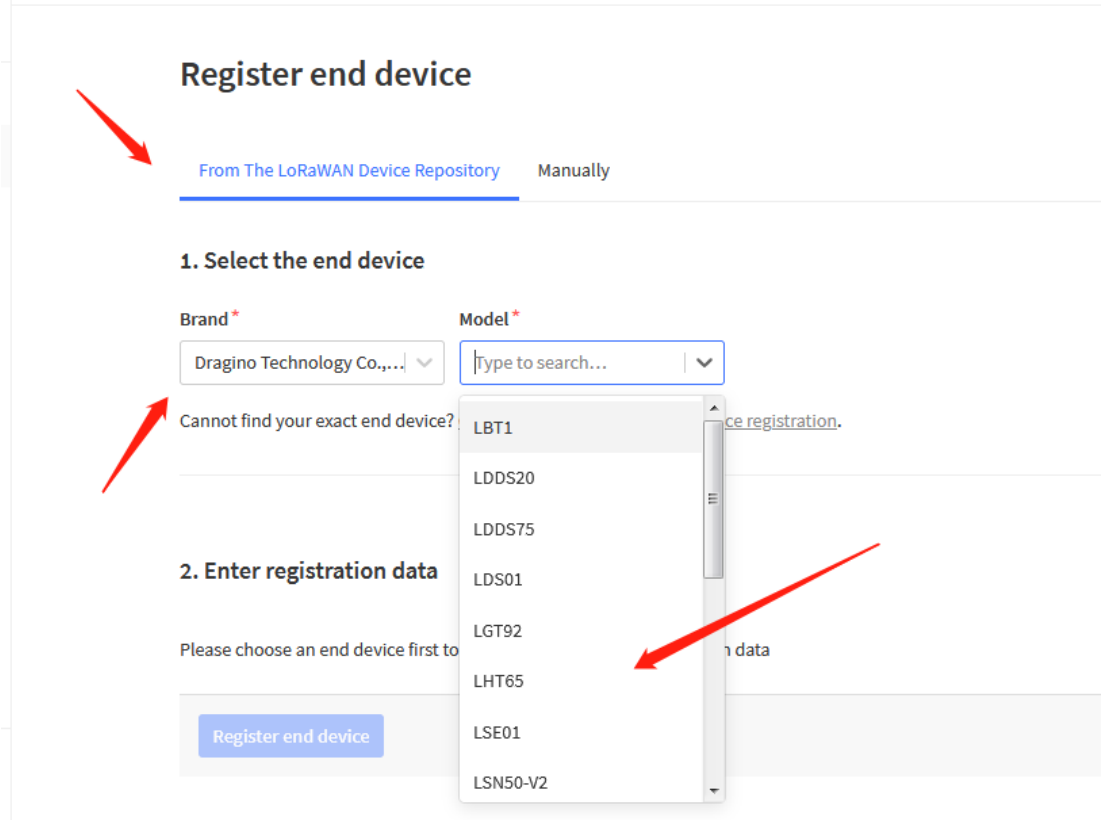

From The LoRaWAN Device Repository Manually

From The LoRaWAN Device Repository Manually

1. Select the end device

Brand [Ⓞ]* Model [Ⓞ]* Hardware Ver. [Ⓞ]* Firmware Ver. [Ⓞ]* Profile (Region) ^{*}



LDS02
MAC V1.0.3, PHY V1.0.3 REVA, Over the air activation (OTAA), Class A
LoRaWAN Door Sensor
[Product website](#) [Data sheet](#)

2. Enter registration data

Frequency plan [Ⓞ]*

AppEUI [Ⓞ]*

Add APP KEY and DEV EUI

2. Enter registration data

Frequency plan *

Europe 863-870 MHz (SF12 for RX2)

The frequency plan used by the end device

AppEUI *

..... 00

The AppEUI uniquely identifies the owner of the end device. If no AppEUI is provided by the device manufacturer (usually for dev

DevEUI *

.....

The DevEUI is the unique identifier for this end device

AppKey *

.....

The root key to derive session keys to secure communication between the end device and the application

End device ID *

my-new-device

After registration

Step 2: [Power on](#) LDS02 and it will auto join to the TTN V3 network. After join success, it will start to upload message to TTN V3 and user can see in the panel.

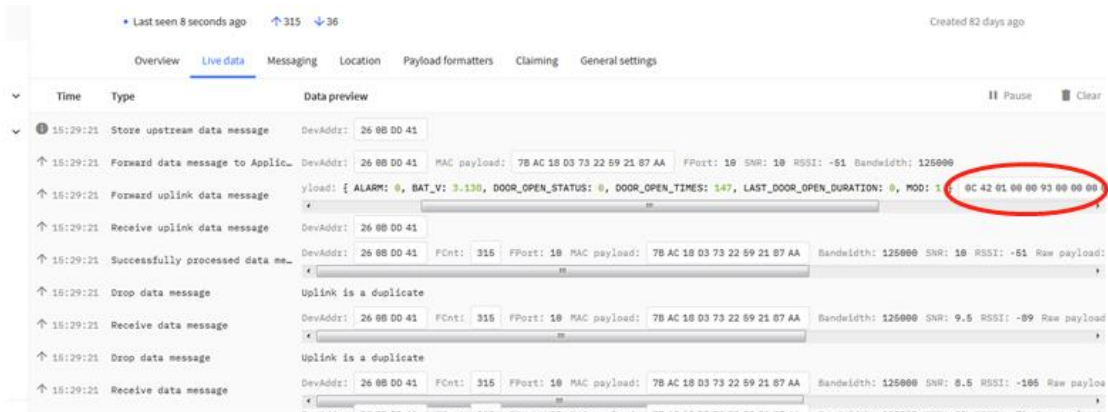

4.3 Uplink Payload

Important!

Uplink Payload total 10 bytes.

Size(bytes)	2	1	3	3	1
value	Status&BAT	MOD Always:0x01	Total open door events	Last door open duration (unit: min)	Alarm

Example:

Example Payload Decoder in TTN V3:

http://www.dragino.com/downloads/index.php?dir=LoRa_End_Node/LDS02/Payload/

4.4 Downlink Payload

Downlink Control Type	Type Code	Downlink payload size(bytes)
TDC (Transmit Time Interval—Keep Alive Interval)	0x01	4
RESET	0x04	2
Set confirmed mode	0x05	2
Clear Counting	0xA6	2
Enable/Disable Alarm	0xA7	2
Control ADR/DR	0xA8	3
Set Alarm Timeout	0xA9	4

This could be interesting! It could be reset everyday at 00:01

Example Downlink payload setting in TTN V3:

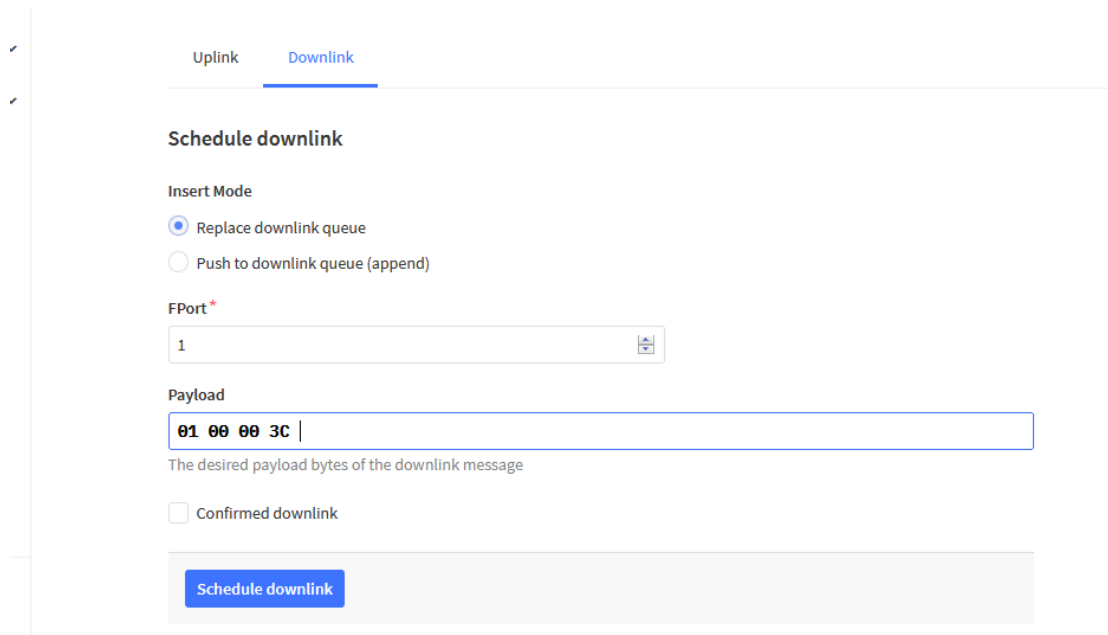

LoRaWAN private LoRaWAN networks - The Things Industries

Type Code 0x01

If the payload=0100003C, means to control the LDS02's Keep Alive interval to 0x00003C=60(S)

Type Code 0x04

If payload = 0x04FF, it will reset the LDS02.

Type Code 0x05

0x05 00: Set uplink to LoRaWAN unconfirmed mode

0x05 01: Set uplink to LoRaWAN confirmed mode

Type Code 0xA6

Example: 0xA601: Clear Counting

For LDS02: reset both count number and time.

Type Code 0xA7

0xA7 01 : Equal to AT+DISALARM=1

0xA7 00 : Equal to AT+DISALARM=0

Type Code 0xA8

Format: 0xA8 aa bb

aa: 1: Enable ADR; 0: Disable ADR (Same as AT+CADR command)

bb: set DR (Same as AT+CDATARATE ,only valid after ADR=0)

Example: 0x A8 00 02 : Set ADR=0 and DR=1

Type Code 0xA9

See [Alarm Base Timeout](#) for detail.

4.5 Integrate with Datacake

Datacake provides a human friendly interface to show the sensor data, once we have data in TTN V3, we can use Datacake to connect to TTN V3 and see the data in Datacake. Below are the steps:

Step 1: Be sure that your device is programmed and properly connected to the network at this time.

Step 2: To configure the Application to forward data to Datacake you will need to add integration. To add the Datacake integration, perform the following steps:

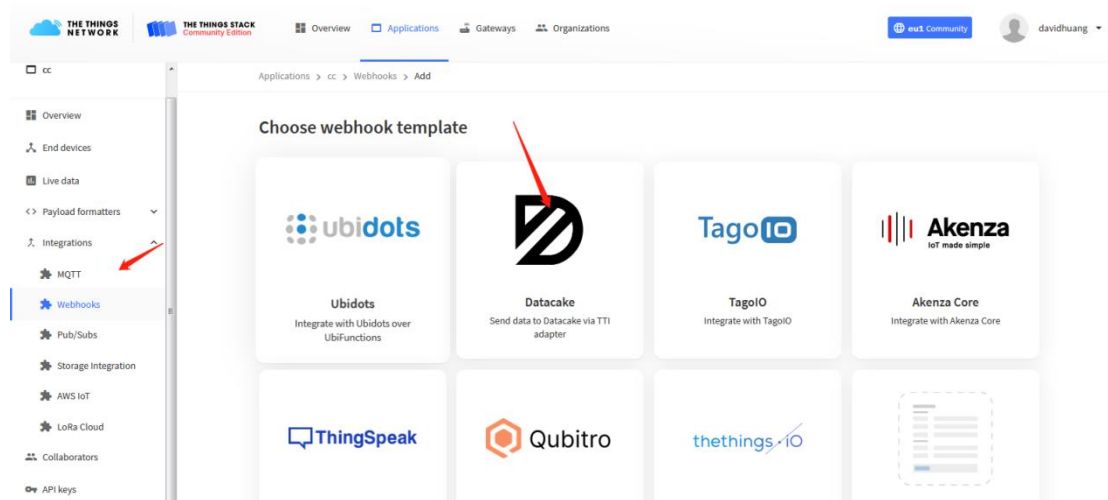

Applications > lgt92test > Webhooks > Add > Datacake

Add custom webhook

Template information



Datacake

Send data to Datacake via TTI adapter

[About Datacake](#) | [Documentation](#)

Template settings

Webhook ID *

Token *

Datacake API Token

Create datacake webhook

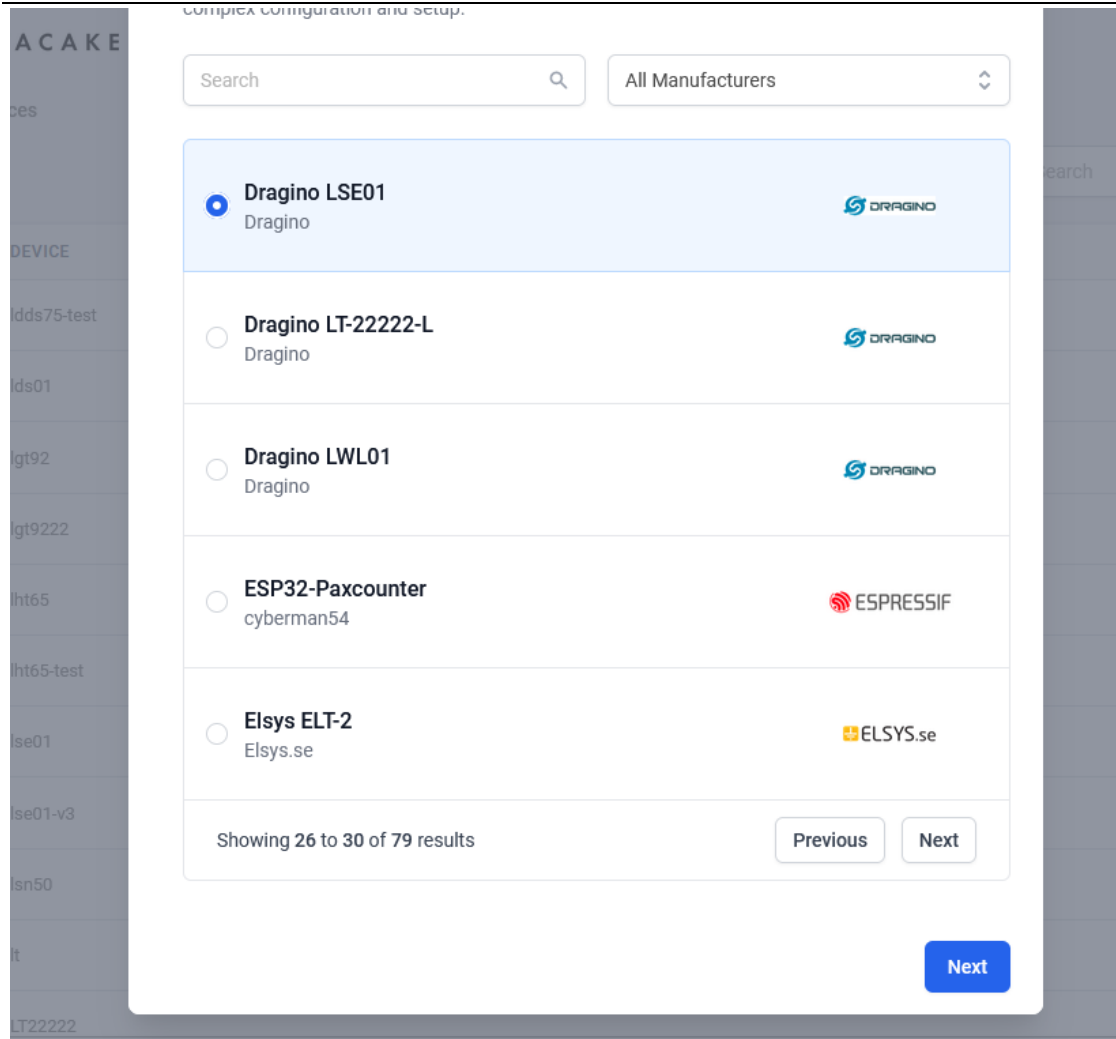

Step 3: Create an account or log in Datacake.

Step 4: Search LDS02 and add DevEUI.

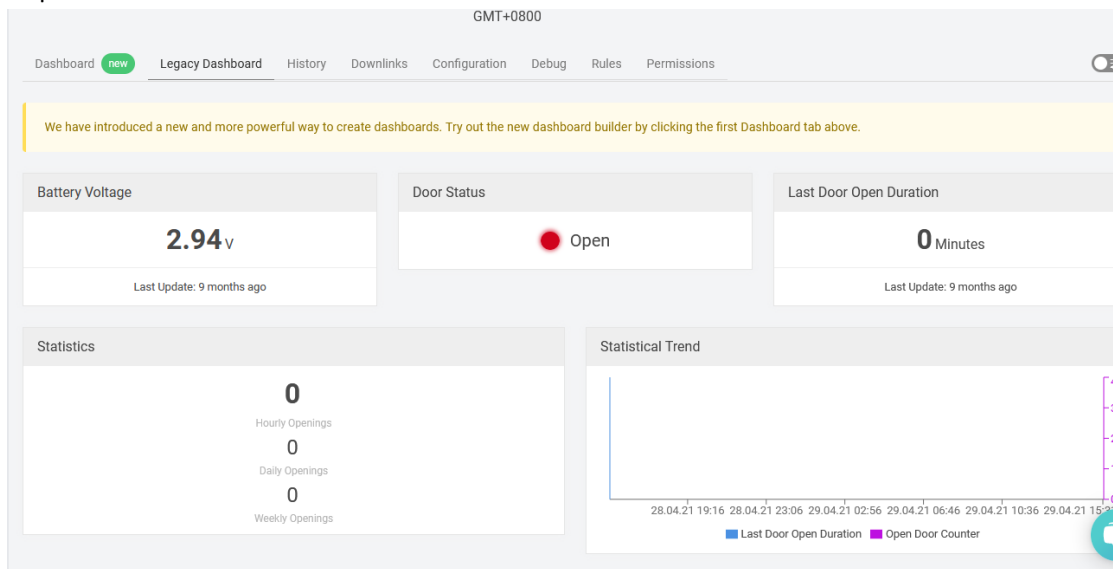

4.6 Alarm Base on Timeout

LDS02 can monitor the timeout for a status change, this feature can be used to monitor some event such as open fridge too long etc.

User configure this feature by using:

AT Command to configure:

- **AT+TTRIG=1,30** → When status change from close to open, and device keep in open status for more than 30 seconds. LDS02 will send an uplink packet, the Alarm bit (the lowest bit of 10th byte of payload) on this uplink packet is set to 1.
- **AT+TTIG=0,0** → Default Value, disable timeout Alarm.

Interesting depending on where the error is placed (ex: the door of the house)

Downlink Command to configure:

Command: 0xA9 aa bb cc

A9: Command Type Code

aa: status to be monitor

bb cc: timeout.

If user send 0xA9 01 00 1E: equal to AT+TTRIG=1,30

Or

0xA9 00 00 00: Equal to AT+TTRIG=0,0. Disable timeout Alarm.

4.7 LEDs

Action	LED behavior
Power On	GREEN on 1s, RED on 1s, BLUE on 1s
Joined successful	GREEN LED on 5s
Send an uplink message	GREEN LED blinks once
Got a downlink message	BLUE LED blinks once

5. Battery & How to replace

5.1 Battery Type and replace

LDS02 is equipped with 2 x AAA LR03 batteries. If the batteries running low (shows 2.1v in the platform). User can buy generic AAA battery and replace it.

Note:

- 1) The LDS02 doesn't have any screw, use can use nail to open it by the middle.
- 2) Make sure the direction is correct when install the AAA batteries.

Important Notice: Make sure use new AAA LR03 battery and the battery doesn't have broken surface.

Example of AAA LR03 batter:



5.2 Battery Life Analyze

Dragino battery powered products are all run in Low Power mode. User can check the guideline from this link to calculate the estimate battery life:

https://www.dragino.com/downloads/downloads/LoRa_End_Node/Battery_Analyze/DRAGINO_Battery_Life-Guide.pdf

6. Use AT Command

6.1 Access AT Command

LDS02 supports AT Command set. User can use a USB to TTL adapter to configure LDS02 via use AT command, as below.

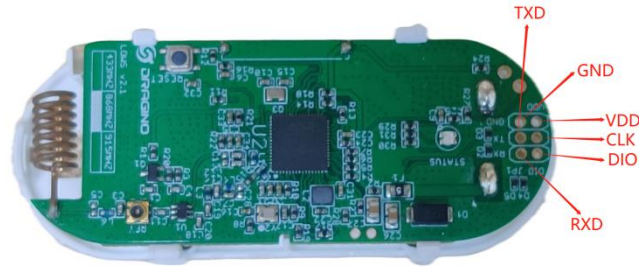

USB to TTL <- -> LDS02

RX <- -> TXD

TX <- -> RXD

GND <- -> GND

In PC, User needs to set serial tool (such as putty, SecureCRT) baud rate to **115200** to access to access serial console of LDS02. Below is the output for reference:

The AT Access password is **123456**.

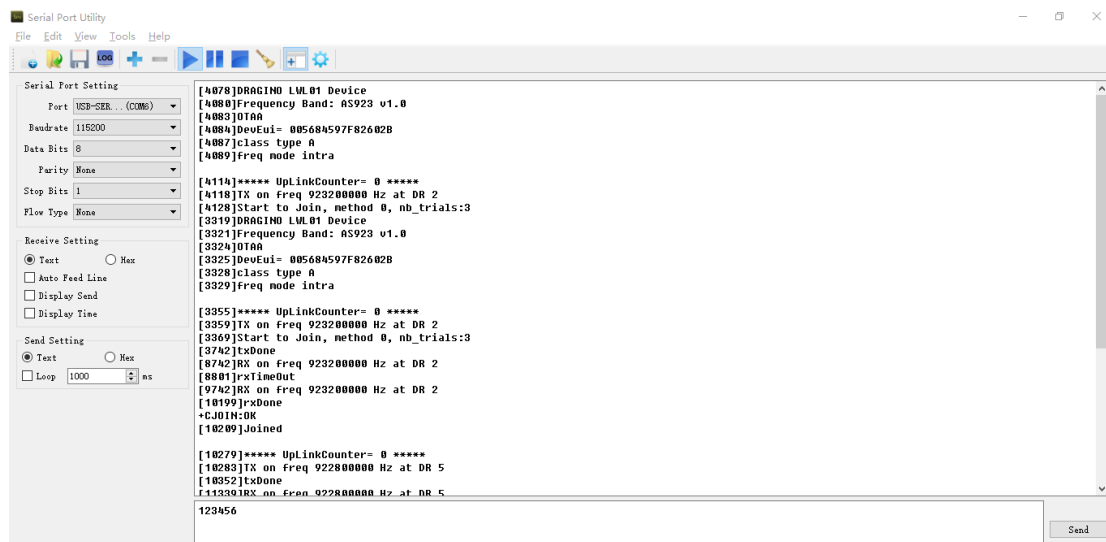

Each AT Command need to add an ENTER at the end before send.

Warning!

When entering the first command, the **RED LED** will on and user can now input AT Commands.

After input all needed AT Commands, please input AT+CLPM=1 to set the device to work in Low Power mode and **RED LED** will be off.

More detail AT Command manual can be found at [AT Command Manual](#)

7. FAQ

7.1 How to upgrade the image?

User can upgrade the firmware of LDS02 for bug fix, new features, or change working region. The upgrade instruction are here:

[http://wiki.dragino.com/index.php?title=Firmware Upgrade Instruction](http://wiki.dragino.com/index.php?title=Firmware_Upgrade_Instruction)

7.2 How to change the LoRa Frequency Bands/Region?

If user has for example US915 frequency and want to change it to AS923 frequency. User can follow the introduction for [how to upgrade image](#). When download the images, choose the required image file for download.

7.3 Can I disable uplink for each event to save battery life?

Yes, User can use below method to disable this:

via AT Command:

AT+DISALARM=1, End node will only send packet in TDC time.

AT+DISALARM=0, End node will send packet in TDC time or status change for door sensor.

via LoRaWAN downlink Command:

0xA701 : Equal to AT+DISALARM=1

0xA700 : Equal to AT+DISALARM=0

8. Order Info

Part Number: LDS02-XXX

XXX:

- **EU433:** frequency bands EU433
- **EU868:** frequency bands EU868
- **KR920:** frequency bands KR920
- **CN470:** frequency bands CN470
- **AS923:** frequency bands AS923
- **AU915:** frequency bands AU915
- **US915:** frequency bands US915
- **IN865:** frequency bands IN865
- **CN779:** frequency bands CN779

9. Packing Info

Package Includes:

- ✓ LDS02 x 1

Dimension and weight:

- ✓ Device Size: 69.2 x 29.2 x 14.8 mm

10. Support

- Support is provided Monday to Friday, from 09:00 to 18:00 GMT+8. Due to different timezones we cannot offer live support. However, your questions will be answered as soon as possible in the before-mentioned schedule.
- Provide as much information as possible regarding your enquiry (product models, accurately describe your problem and steps to replicate it etc) and send a mail to

support@dragino.com