



3D ToF People Counting Sensor

Featuring LoRaWAN®

VS132

User Guide



Safety Precautions

Milesight will not shoulder responsibility for any loss or damage resulting from not following the instructions of this operating guide.

- ❖ The device must not be disassembled or remodeled in any way.
- ❖ To avoid risk of fire and electric shock, do keep the product away from rain and moisture before installation.
- ❖ Do not place the device where the temperature is below/above the operating range.
- ❖ Do not touch components which may be hot.
- ❖ The device must never be subjected to shocks or impacts.
- ❖ Make sure the device is firmly fixed when installing.
- ❖ Do not expose the device to where laser beam equipment is used.
- ❖ Use a soft, dry cloth to clean the lens of the device.

Declaration of Conformity

VS132 is in conformity with the essential requirements and other relevant provisions of the CE, FCC, and RoHS.

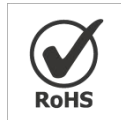

Copyright © 2011-2023 Milesight. All rights reserved.

All information in this guide is protected by copyright law. Whereby, no organization or individual shall copy or reproduce the whole or part of this user guide by any means without written authorization from Xiamen Milesight IoT Co., Ltd.

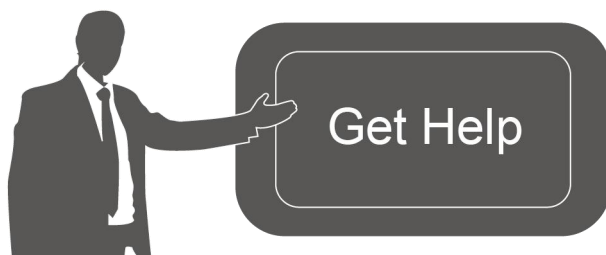

For assistance, please contact

Milesight technical support:

Email: iot.support@milesight.com

Support Portal: support.milesight-iot.com

Tel: 86-592-5085280

Fax: 86-592-5023065

Address: Building C09, Software Park
Phase III, Xiamen 361024,
China

Revision History

Date	Doc Version	Description
Oct. 15, 2022	V 1.0	Initial version
Dec. 6, 2022	V 1.1	<ol style="list-style-type: none">1. Support U-turn counting;2. Support Milesight DeviceHub Management3. Delete LoRaWAN version V1.1.0 option4. Add counting clear downlink command
Feb. 15, 2023	V 1.2	<ol style="list-style-type: none">1. Add HTTP Post feature2. Add door installation note3. Change reporting interval command definition

Contents

1. Product Introduction	5
1.1 Overview	5
1.2 Key Features	5
2. Hardware Introduction	5
2.1 Packing List	5
2.2 Hardware Overview	6
2.3 Ethernet Port Indicators	6
2.4 Dimensions (mm)	6
3. Power Supply	6
4. Access the Sensor	7
4.1 Access with Wi-Fi	7
4.2 Access with Ethernet	8
5. Operation Guide	9
5.1 Preview	9
5.2 Configuration	10
5.2.1 Rule	10
5.2.2 Traffic	13
5.2.3 Communication	14
5.2.4 System	19
6. Installation Instruction	22
6.1 Installation Height	23
6.2 Covered Detection Area	23
6.3 Environment Requirements	23
6.4 Installation	24
6.5 Factors Affecting Accuracy	26
7. Device Payload	27
7.1 Uplink Data	27
7.2 Downlink Command	28

1. Product Introduction

1.1 Overview

VS132 is a LoRaWAN® 3D ToF people counting sensor designed to count the number of people entering and exiting. Applied the most advanced Time-of-Flight technology, VS132 only obtains depth maps instead of images to protect privacy and provide a high level of accuracy up to 99.5%. Cooperating with Milesight LoRaWAN® gateway and the Milesight IoT Cloud, it allows users to monitor the flow of people and trigger linkage to control other devices via browser or mobile App remotely. VS132 can be widely used in entrances or corridors of retail stores, malls, offices, subways, etc.

1.2 Key Features

- Up to 99.5% accuracy basing on advanced 3D Time-of-Flight technology
- Obtain depth map without images capturing, free from privacy concerns
- Effective in low-light or complete dark environments
- Bi-directional Counting
- Store a million data records locally
- DC or PoE power supply optional
- Exquisite design for multiple installation scenarios
- Equipped with Wi-Fi and Ethernet port for web GUI configuration
- Acquire people counting data either from LoRaWAN® or Ethernet port (HTTP Post, CGI)
- Function well with standard LoRaWAN® gateways and network servers
- Quick and easy management with Milesight IoT Cloud

2. Hardware Introduction

2.1 Packing List



1 × VS132 Device

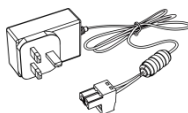

1 × Power Adapter

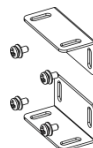

2 × Ear Mounting Kits



4 × Wall Mounting Kits

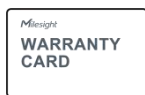

1 ×

Warranty Card



1 ×

Quick Guide



If any of the above items is missing or damaged, please contact your sales representative.

2.2 Hardware Overview

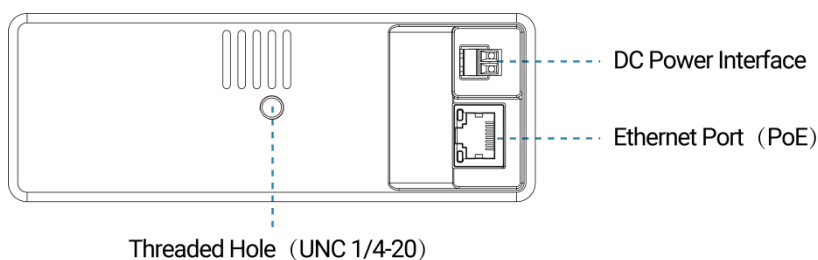

2.3 Ethernet Port Indicators

Indicator	Status	Description
Link Indicator (Orange)	Off	Disconnected
	Blinking	Transmitting data
	On	Connected
Rate Indicator (Green)	Off	100 Mbps mode
	On	10 Mbps mode

2.4 Dimensions (mm)

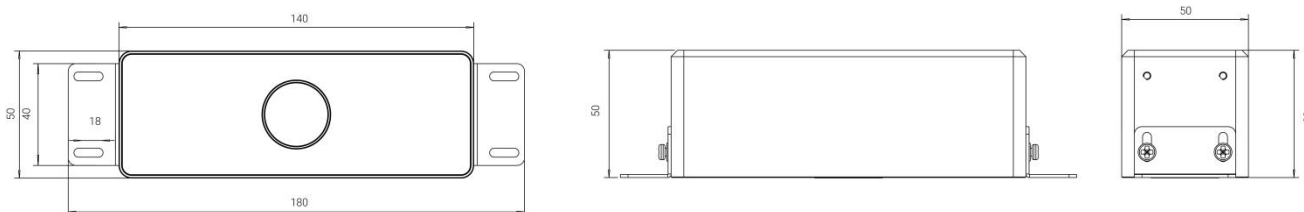

3. Power Supply

VS132 can be powered by 802.3at standard PoE or power adapter (12VDC, 2A). If the both interfaces are connected, the device will be powered by the former method (PoE).

- **Powered by DC Power Adapter**

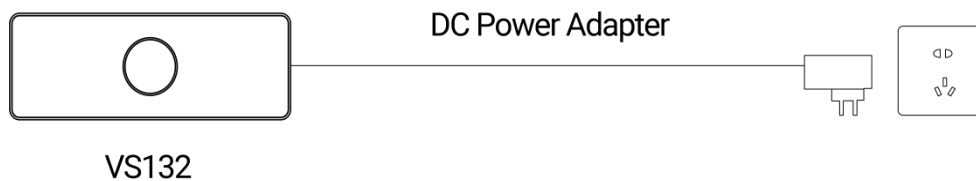

- **Powered by a PoE Switch**

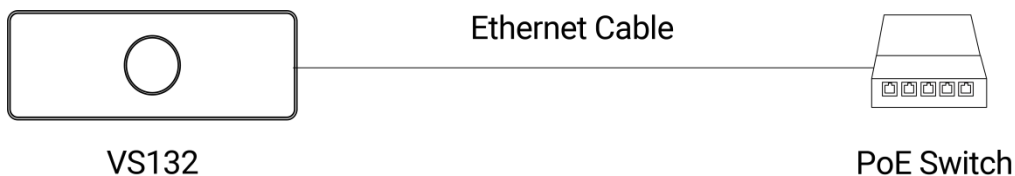

- **Powered by a PoE Injector**

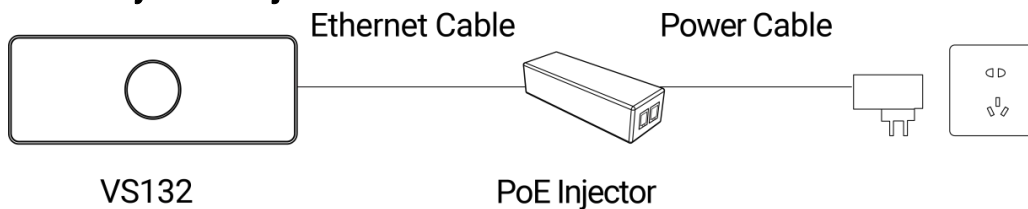

4. Access the Sensor

VS132 sensor provides user-friendly web GUI for configuration and users can access it via Wi-Fi connection or Ethernet port. The recommended browsers are Internet Explorer, Firefox, Chrome, Microsoft Edge, and Safari. The default IP of Ethernet port is **192.168.5.220**, the default IP of Wi-Fi is **192.168.1.1**, and default SSID is **People Counter_XXXXXX**.

Note: The default information can be found on the label.

4.1 Access with Wi-Fi

Step 1: Power on the device.

Step 2: Enable the Wireless Network Connection on your computer and search for corresponding access point, then connect computer to this access point.

Step 3: Open the Browser and type 192.168.1.1 to access the web GUI.

Step 4: Select the language.

Step 5: Users need to set the password and three security questions when using the sensor for the first time (three questions can be skipped by refreshing webpage). After configuration, log in with username (admin) and custom password.

Note:

1) Password must be 8 to 16 characters long, which contains at least two kinds or more in combination with numbers, lowercase letters, uppercase letters and special characters .

2) You can click the "forgot password" in login page to reset the password by answering three security questions when you forget the password if you set the security questions in advance.

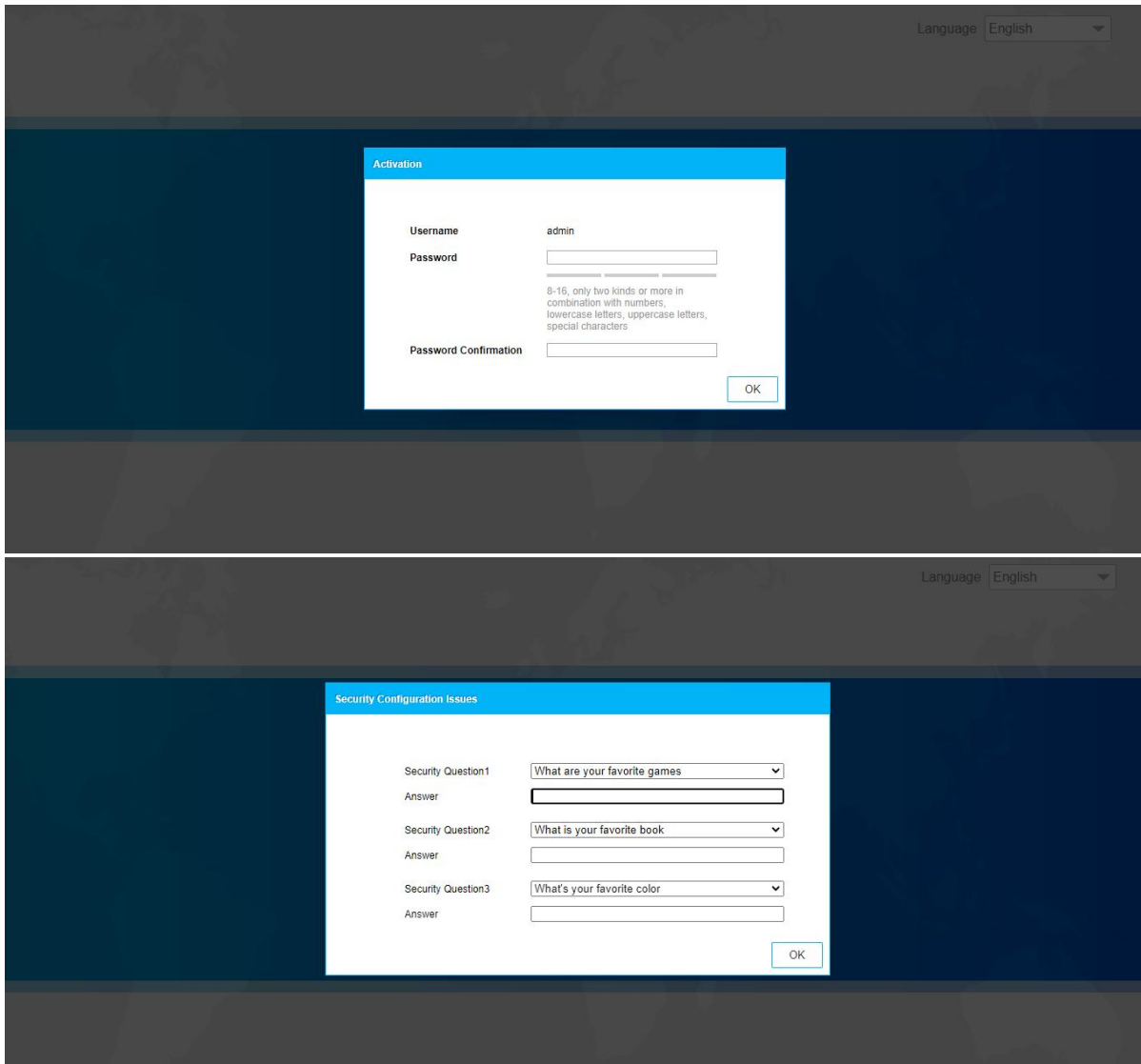

4.2 Access with Ethernet

Step 1: Power on the device and connect the Ethernet port to a PC.

Step 2: Change the IP address of computer to 192.168.5.0 segment as below:

- a. Go to **Start** → **Control Panel** → **Network and Internet** → **Network and Sharing Center** → **Ethernet** → **Properties** → **Internet Protocol Version 4 (TCP/IPv4)**.

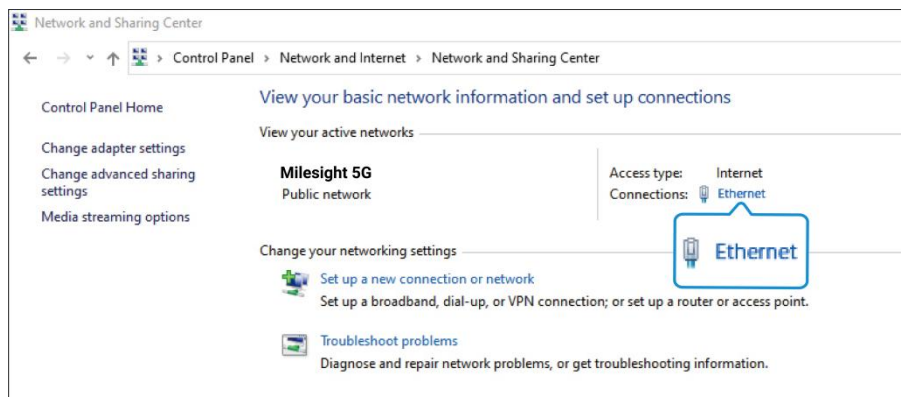

- b. Enter an IP address that in the same segment with sensor (e.g. 192.168.5.61, but please note that this IP address shall not conflict with the IP address on the existing network);

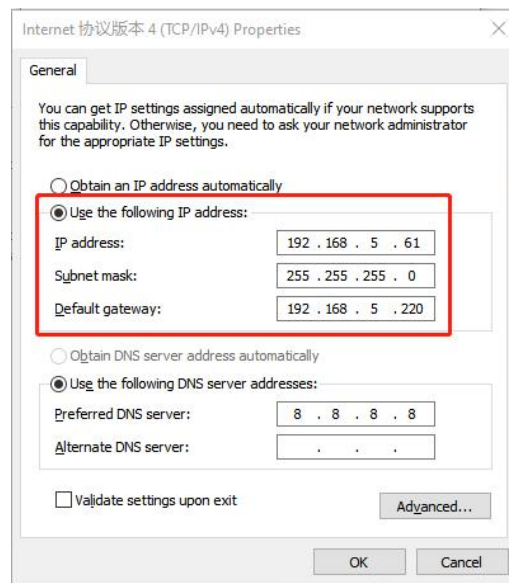

Step 3: Open the Browser and type 192.168.5.220 to access the web GUI. After logging on web GUI successfully, user is allowed to view configuration page.

5. Operation Guide

5.1 Preview

After logging on to the device web GUI successfully, user is allowed to view live video as follows.

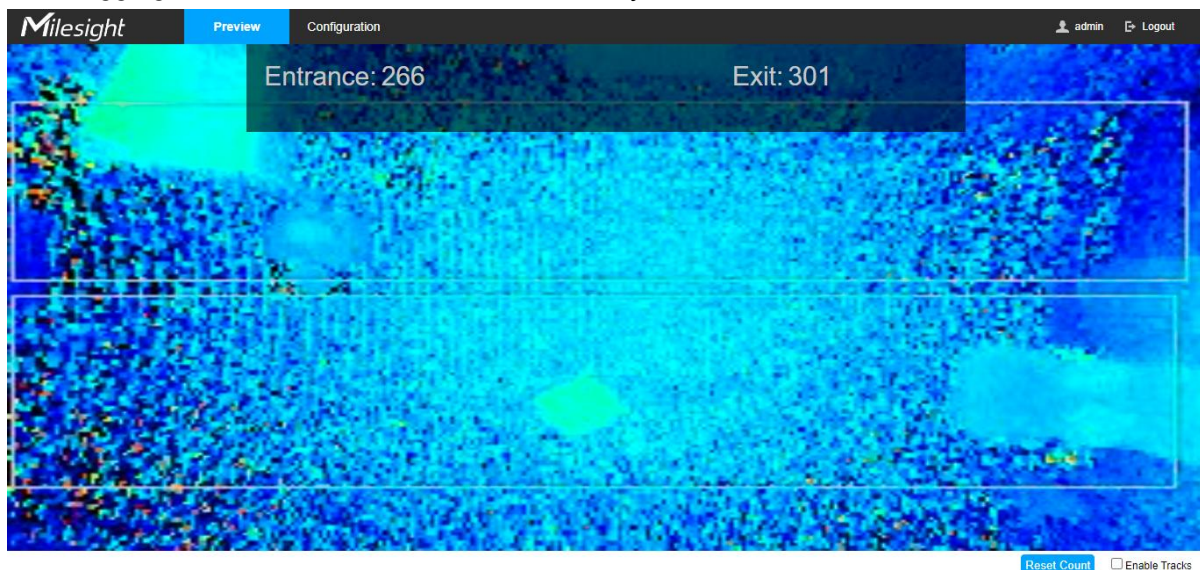

Parameters	Description
Reset Count	Clear accumulated entrance and exit people counting values.

Enable Tracks	When enabled, there is tracking line when people pass the detection area.
---------------	---

5.2 Configuration

5.2.1 Rule

Rule Configuration

Users can set the rules and ROI to ensure accurate counting.

[Rule Configuration](#) Pass Area ROI

Rule Configuration		
Deploy Height	<input type="text" value="3000"/>	mm(1500~3000)
Deploy Angle	<input type="text" value="0"/>	° (-10~10)
Max Target Height	<input type="text" value="2000"/>	mm(500~2500)
Min Target Height	<input type="text" value="1000"/>	mm(500~2500)
U-turns Counting	<input checked="" type="checkbox"/>	

Parameters	Description
Deploy Height	Set the device deploy height from the ground.
Deploy Angle	Set the deploy angle based on horizontal surface. 
Max Target Height	Set the maximum target height, then the device will ignore the object higher than this height.
Min Target Height	Set the minimum target height, then the device will ignore the object shorter than this height.
U-turns Counting	When enabled, the device will count the in and out values repeatedly if people wandering between the two areas; when disabled, the device will only count when people pass from one area to another area and get out of device sight.

U-turns Counting On

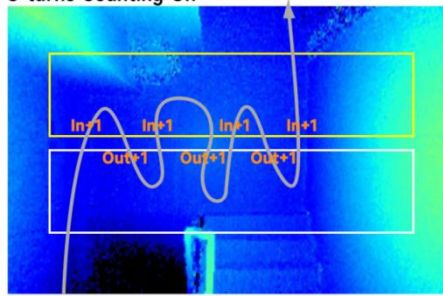

U-turns Counting Off

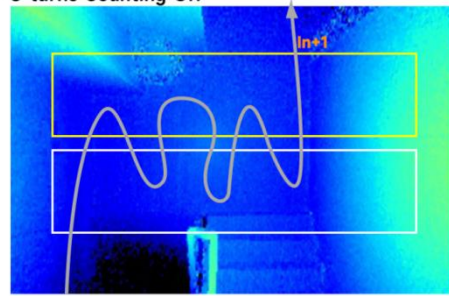

Note: Due to the error in ToF distance measurement (0.05 m), the Max Target Height should be set as maximum pedestrian height plus 0.05 m and the Min Target Height as minimal pedestrian height minus 0.05 m in the actual applications. For example, if the pedestrian height is 1.6 m to 1.8 m, the Max and Min Target Height should be configured as 1.85 m and 1.55 m respectively.

Report Settings

Report Protocol LoRaWAN HTTP

Periodic Report

Period min(1~1080)

Report Settings

Report Protocol LoRaWAN HTTP

HTTP Method

URL

User Name

Password

Trigger Report

Periodic Report

Period min(1~1080)

Parameters	Description
Report Protocol	Select uplink protocol as LoRaWAN® or HTTP.
LoRaWAN	
Periodic Report	Report the people counting data periodically. See uplink format on section 7 .
Period	Set the period of reporting periodic report.

	Range: 1-1080 mins, default: 30 mins
HTTP	
HTTP Method	It's fixed as Post.
URL	The device will post the people counting data in json format to this URL.
User Name	The username used for authentication.
Password	The password used for authentication.
Trigger Report	Report the people counting data immediately when the in/out value changes. Uplink format: <pre>{ "event": "People Counting", "device_name": "People Counter", "time": "2022/12/20 18:15:52.520", "report_type": "trigger", "in": 1, //Quantity of change "out": 0, }</pre>
Periodic Report	Report the accumulated people counting data periodically. Uplink format: <pre>{ "event": "People Counting", "device_name": "People Counter", "time": "2022/12/20 18:15:52.520", "report_type": "period", "in_counted": 10, //Accumulated in count "out_counted": 10, //Accumulated out count "capacity_counted": 0, //in_count-out_count }</pre>
Period	Set the period of reporting periodic report. Range: 1-1080 mins, default: 30 mins

Pass Area ROI

Region of interest (often abbreviate ROI), is a selected subset of samples within a dataset identified for a particular purpose. Users can select entrance area and exit area to record the people count values which indicate the number of people passing from one area to another.

Step 1: Click **Set Entrance Area** or **Set Exit Area**.

Step 2: Drag the mouse to draw detection area. If there is already an area, you can click **Clear**.

Step 3: Click **Stop Drawing**, then click **Save**.

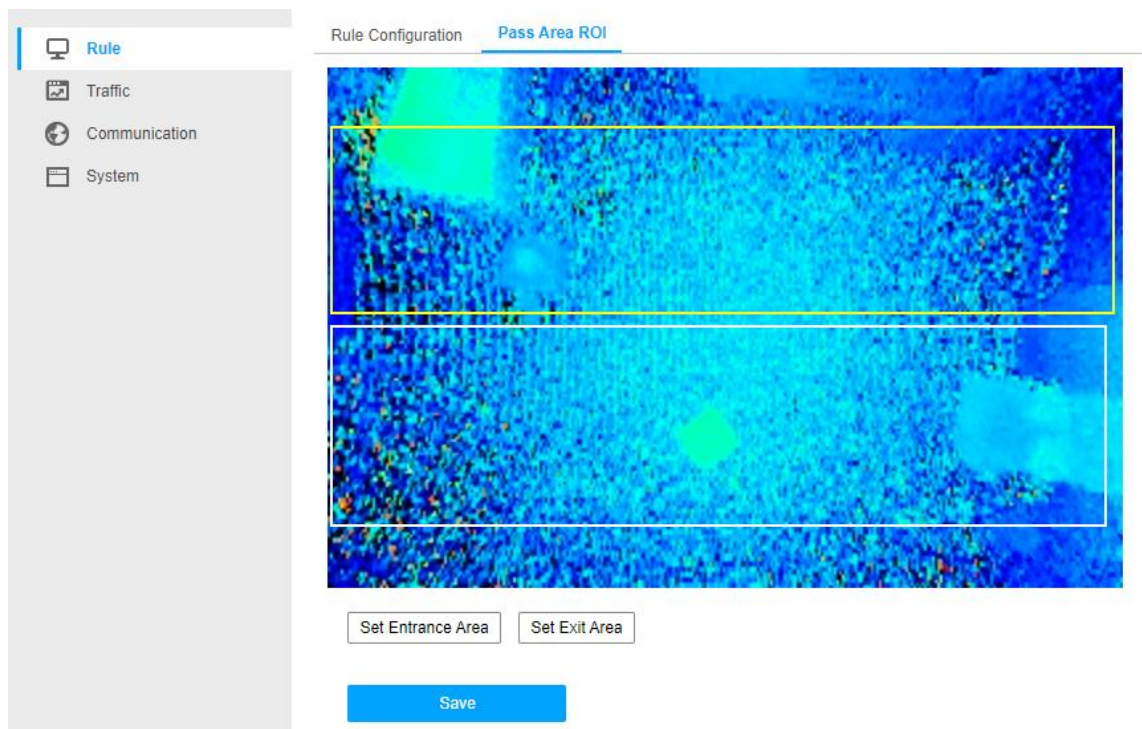

Note: The detection area had better not fill the field of view, leaving a certain interspace.

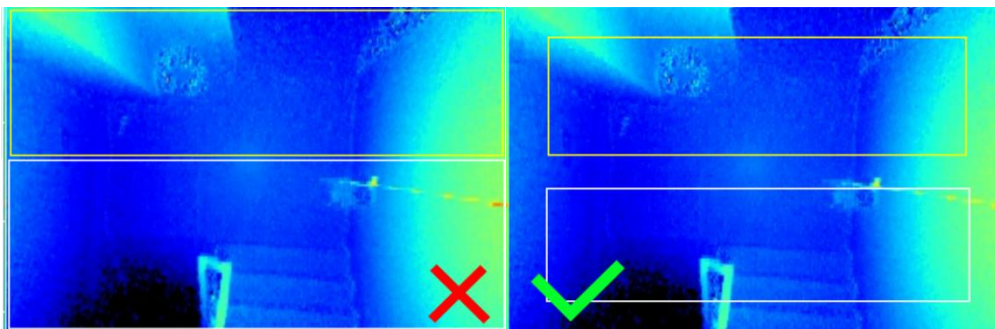

5.2.2 Traffic

The sensor will count the number of people who passing from one area to another, then upload the count value according to the reporting interval. Before using this feature, **ensure the device time is correct on [System > Time Configuration](#) page.**

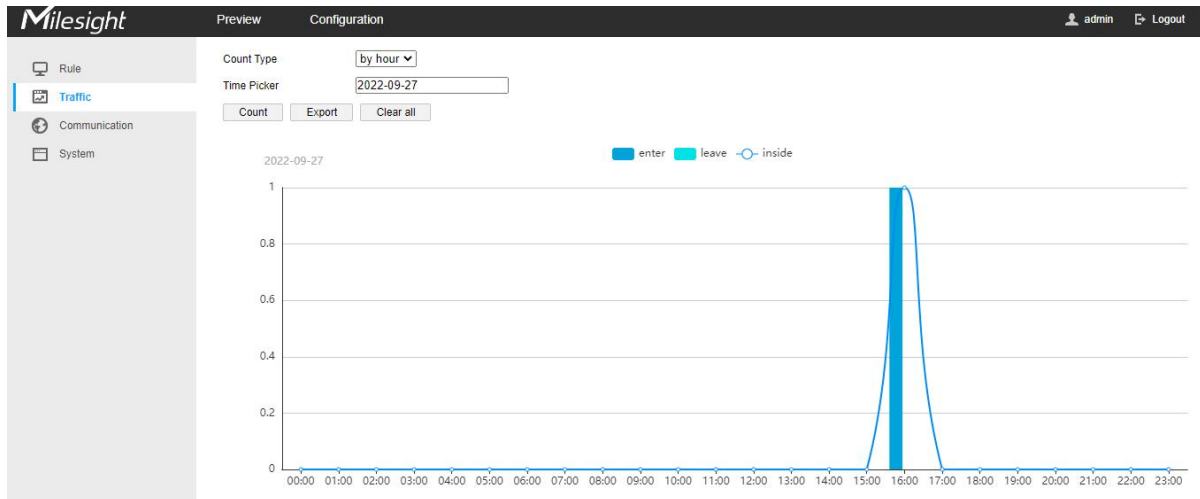

Parameters	Description
Count Type	Select the count type to generate the graph.
Time Picker	Select the time or time range to generate the graph.
Count	Click to generate the graph according to picked time or time range.
Export	Export the historical traffic data as csv file. The recorded and saved time is fixed by hour.
Clear all	Click to clear all saved data records.

5.2.3 Communication

5.2.3.1 Ethernet

VS132 provides a Ethernet port for wired access. Besides, users can get the people counting data or configure the device via CGI. For CGI document, please contact with Milesight IoT support: iot.support@milesight.com.

Ethernet WLAN LoRa

TCP/IP

IPv4 Address:

IPv4 Subnet Mask:

IPv4 Default Gateway:

Preferred DNS Server:

Alternate DNS Server:

MAC Address:

MTU: bytes

Parameters	Description
------------	-------------

IPv4 Address	Set the IPv4 address of the Ethernet port, the default IP is 192.168.
IPv4 Subnet Netmask	Set the Netmask for the Ethernet port.
IPv4 Default Gateway	Set the gateway for the Ethernet port's IPv4 address.
Preferred DNS Server	Set the primary IPv4 DNS server.
Alternative DNS Server	Set the secondary IPv4 DNS server.
MAC Address	Display the MAC address of the Ethernet port.
MTU	Display the maximum transmission unit.
Test	Click to test if the IP is conflicting.

5.2.3.2 WLAN

Ethernet **WLAN** LoRa

WLAN

Enable

Work Mode

SSID

Protocol

Bandwidth

Channel

Security Mode

DHCP Server Settings

LAN IP Address

Netmask

Start Address

End Address

Lease Time min(5~1440)

Preferred DNS Server

Alternate DNS Server

Parameters	Description
Enable	Enable Wi-Fi feature.
Work Mode	Work mode is fixed as AP and can not connect to other access point.

SSID	The unique name for this device Wi-Fi access point.
Protocol	802.11b (2.4 GHz), 802.11g (2.4 GHz), 802.11n (2.4 GHz) are optional.
Bandwidth	20 MHz or 40 MHz are optional.
Channel	Select the wireless channel. Auto, 1,...11 are optional.
Security Mode	No Encryption, WEP Open System, WEP Shared Key, WPA-PSK, WPA2-PSK and WPA-PSK/WPA2-PSK are optional.
DHCP Server Settings	LAN IP Address: IP address that used to access the web GUI of sensor.
	Netmask: identify the subnet where the sensor is located.
	Start Address: define the beginning of IP address pool which assigns to DHCP clients.
	End Address: define the end of IP address pool which assigns to DHCP clients.
	Lease Time (min): the lease time on which DHCP client can use the IP address assigned by the sensor.
	Preferred DNS Server: translate the domain name to IP address.
	Alternate DNS Server: backup DNS server.

5.2.3.3 LoRa

LoRa settings are used for configuring the transmission parameters in LoRaWAN® network.

Ethernet WLAN **LoRa**

Join Status	De-activated
Device EUI	<input type="text" value="24E124600C243505"/>
App EUI	<input type="text" value="24E124C0002A0001"/>
Application Port	<input type="text" value="85"/>
Join Type	<input type="text" value="OTAA"/>
Application Key	<input type="text" value="....."/>
LoRaWAN Version	<input type="text" value="V1.0.3"/>
Region	<input type="text" value="AU915"/>
RX2 Data Rate	<input type="text" value="DR8 (SF12, 500k)"/>
RX2 Frequency	<input type="text" value="923.3"/>
Enable Channel Index	<input type="text" value="0-71"/>

Channel List	
Index	Frequency/MHz
0-15	915.2-918.2
16-31	918.4-921.4
32-47	921.6-924.6
48-63	924.8-927.8
64-71	915.9-927.1

Confirm Mode	<input type="checkbox"/>
Rejoin Mode	<input checked="" type="checkbox"/>
Set the number of detecti...	<input type="text" value="8"/>
ADR Mode	<input checked="" type="checkbox"/>
Spreading Factor	<input type="text" value="SF10-DR2"/>

Parameters	Description
Join Status	LoRaWAN® network joining status of this device.
Device EUI	Unique ID of the device, which can also be found on the label.
App EUI	The Default App EUI is 24E124C0002A0001.
Application Port	The port used for sending and receiving data, default port is 85.
Join Type	OTAA and ABP mode are available.
Application Key	Appkey for OTAA mode, the default key is 5572404C696E6B4C6F52613230313823.
Device Address	DevAddr for ABP mode, the default address is the 5 th to 12 th digits of SN.
Network Session	Nwkskey for ABP mode, the default key is

Key	5572404C696E6B4C6F52613230313823.
Application Session Key	Appskey for ABP mode, the default key is 5572404C696E6B4C6F52613230313823.
LoRaWAN Version	V1.0.2, V1.0.3 are available.
Region	Frequency plan of this device.
Channel	Select the channel from channel list or enter the index to select the frequency channel. Index examples: 1, 40: Enabling Channel 1 and Channel 40 1-40: Enabling Channel 1 to Channel 40 1-40, 60: Enabling Channel 1 to Channel 40 and Channel 60 All: Enabling all channels Null: Indicates that all channels are disabled
RX2 Data Rate	RX2 data rate to receive downlinks.
RX2 Frequency/MHz	RX2 frequency to receive downlinks.
Confirm Mode	If the device does not receive ACK packet from network server, it will resend data once.
Rejoin Mode	Reporting interval \leq 30 mins: the device will send a specific number of LinkCheckReq MAC packets to the network server every 30 mins to validate connectivity; If there is no response, the device will re-join the network. Reporting interval $>$ 30 mins: the device will send a specific number of LinkCheckReq MAC packets to the network server every reporting interval to validate connectivity; If there is no response, the device will re-join the network.
ADR Mode	Allow network server to adjust data rate of the device.
Spreading Factor	If ADR is disabled, the device will send data via this spreading factor.

Note:

- 1) Please contact sales for device EUJ list if there are many units.
- 2) Please contact sales if you need random App keys before purchase.
- 3) Only OTAA mode supports rejoin mode.
- 4) For -868M model, default frequency is EU868; for -915M model, default frequency is AU915.

5.2.4 System

Basic Information

All information about the hardware and software can be checked on this page.

Device Name	People Counter
Product Model	VS132-915M
SN	6600C2435050
Hardware Version	V1.2
Software Version	V_132.1.0.1-a5-b
WLAN MAC Address	00:15:18:10:e1:36
Ethernet MAC Address	00:15:18:10:e0:6c

Time Configuration

Time Zone (GMT + 00: 00) Dublin, Edinburgh, London

NTP Timing

NTP Timing

Server Address

NTP Port 123

Time Interval 480 min(1~10080)

Manual Timing

Manual Timing

Device Time 2000-01-01 00:36:44

Setting Time Synchronize with your computer time

Parameters	Description
Time Zone	Choose the time zone for your location.
NTP Timing	Sync the time with NTP server.
Time Interval	Set the interval to sync time with NTP server.
Manual Timing	Set the device time manually.
Synchronize with computer time	Synchronize the time with your computer.

User Management

User List		Security Question	Modify
No.	Username	User Type	
1	admin	Administrator	

Parameters	Description
Security Question	<p>Click to type administrator password, then set three security questions for your device. In case that you forget the password, you can click Forget Password button on login page to reset the password by answering three security questions correctly.</p> <div style="border: 1px solid #00a0e3; padding: 5px;"> <p>Security Configuration Issues</p> <p>Security Question1 <input type="text" value="What are your favorite games"/></p> <p>Answer <input type="text"/></p> <p>Security Question2 <input type="text" value="What is your favorite book"/></p> <p>Answer <input type="text"/></p> <p>Security Question3 <input type="text" value="What's your favorite color"/></p> <p>Answer <input type="text"/></p> <p style="text-align: right;"><input type="button" value="OK"/> <input type="button" value="Cancel"/></p> </div> <p>There are fifteen default questions below:</p> <div style="border: 1px solid #00a0e3; padding: 5px;"> <p>What are your favorite games</p> <p>What is your favorite book</p> <p>What's your favorite color</p> <p>What is your favorite movie</p> <p>What is your favorite flower</p> <p>What is your first mobile phone brand</p> <p>Where did you go on your first plane ride</p> <p>What is your father's name</p> <p>What is your mother's name</p> <p>What is the name of your high school teacher</p> <p>What is the name of your junior high school teacher</p> <p>What you are most familiar name is roommates school dormitory</p> <p>The most influential name of the person you</p> <p>Who is your favorite celebrity</p> <p>What is your favorite car brand</p> </div>
Modify	Click the admin on the user list, then you can click Modify to change the login password of this device.

Username	<input type="text" value="admin"/>
User Type	<input type="text" value="Administrator"/>
Administrator Password	<input type="password"/>
Password	<input type="password"/>
	8-16, only two kinds or more in combination with numbers, lowercase letters, uppercase letters, special characters
Password Confirmation	<input type="password"/>

Remote Management

You can connect the device to the Milesight DeviceHub management platform on this page so as to manage the device centrally and remotely. For more details, please refer to [DeviceHub User Guide](#). Before connecting, ensure the device has connected to network via Ethernet port and Internet connection is seamless.

DeviceHub

Status	Disconnected
Server Address	<input type="text" value="192.168.60.228"/>
Activation Method	<input type="text" value="Account"/>
Account Name	<input type="text"/>
Password	<input type="password"/>

Connect

Parameters	Description						
Status	Show the connection status between the device and the DeviceHub.						
Disconnect	Click this button to disconnect the device from the DeviceHub. <div style="background-color: #007bff; color: white; padding: 5px; text-align: center; font-weight: bold;">DeviceHub</div> <table> <tr> <td>Status</td> <td style="color: green;">Connected</td> <td style="text-align: right;"><input type="button" value="Disconnect"/></td> </tr> <tr> <td>Server Address</td> <td colspan="2"><input type="text" value="192.168.60.228"/></td> </tr> </table>	Status	Connected	<input type="button" value="Disconnect"/>	Server Address	<input type="text" value="192.168.60.228"/>	
Status	Connected	<input type="button" value="Disconnect"/>					
Server Address	<input type="text" value="192.168.60.228"/>						
Server Address	IP address or domain of the DeviceHub management server.						
Activation Method	Select activation method to connect the device to the DeviceHub server, options are Authentication Code and Account .						

System Maintenance

Language

Language

Reboot

Restart the device.

Reset

Recovery device basic configuration.

Recovery device to factory settings.

Upgrade

Upgrade Image

Status

Explanation: The upgrade process takes 1-10 minutes, do not turn off the power, complete automatic restart after the upgrade.

Parameters	Description
Language	English or simplified Chinese are optional.
Reboot	Restart the device immediately.
Reset	<p>Basic Recovery: keep the IP settings, user information and stored counting data when resetting.</p> <p>All Recovery: reset device to factory default, which needs to verify admin password.</p>
Upgrade	<p>Click the Browse button and select the upgrading file, then click the Upgrade button to upgrade. The update is done when the system reboots successfully.</p> <p>Note: The upgrade process takes about 1-10 minutes. Do not turn off the power and complete automatic restart after the upgrade.</p>

6. Installation Instruction

Parameter definition:

Parameters	Explanation	Value
H	Installation height	≤3 m
d	Minimum detection distance of VS132	0.5 m
Δd	Distance measurement error of VS132	0.05 m
h _{max}	Maximum pedestrian height	Example 1.8 m
h _{min}	Minimum pedestrian height	Example 1.6 m
α	ToF horizontal field of view angle	92.5°
β	ToF vertical field of view angle	67°
x	Length of detection range	
y	Width of detection range	

6.1 Installation Height

The maximum installation height is 3 m and the minimum installation height is $h_{\max}+d+\Delta d$. For example, when the maximum pedestrian height is 1.8 m, then the minimum installation height is $1.8+0.5+0.05=2.35$ m.

6.2 Covered Detection Area

The detection area covered by the device is related to the field of view angle of the device, the installation height and the target height. The length of the detection area is approximately $x=2.1 \times (H-h_{\min})$ and the width of the detection area is approximately $y=1.32 \times (H-h_{\min})$.

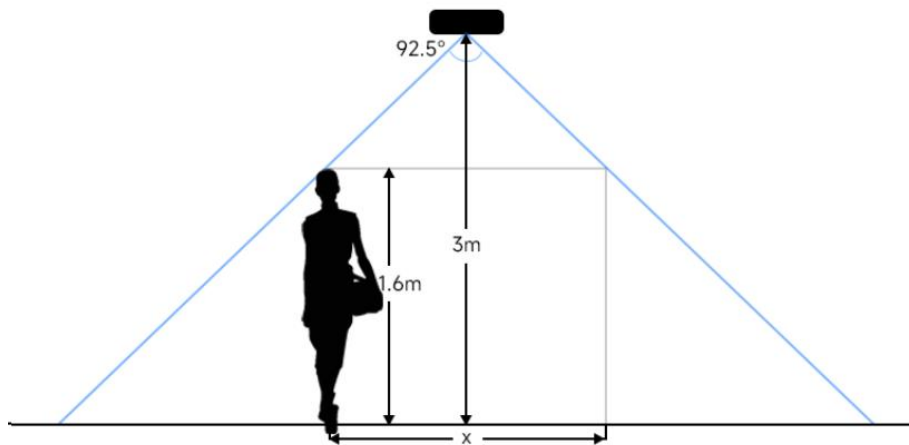

For example, if the Minimum height of pedestrians is 1.6 m, the detection area corresponding to each installation height is as follows:

Installation Height	FoV Monitored Area (m)	Detection Area (m)
2.4	5.01 × 3.18	1.67 × 1.06
2.5	5.22 × 3.31	1.88 × 1.19
2.6	5.43 × 3.44	2.09 × 1.32
2.7	5.64 × 3.57	2.30 × 1.46
2.8	5.85 × 3.71	2.51 × 1.59
2.9	6.06 × 3.84	2.72 × 1.72
3.0	6.27 × 3.97	2.92 × 1.85

6.3 Environment Requirements

- Black floor/carpet may affect the depth map to produce a lot of noise, but will not affect the device to count people.

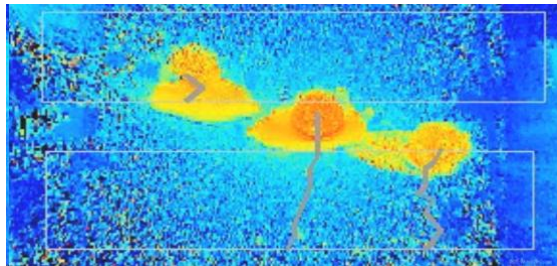

- Avoid direct point light to ToF sensor, which may result in incorrect counting.

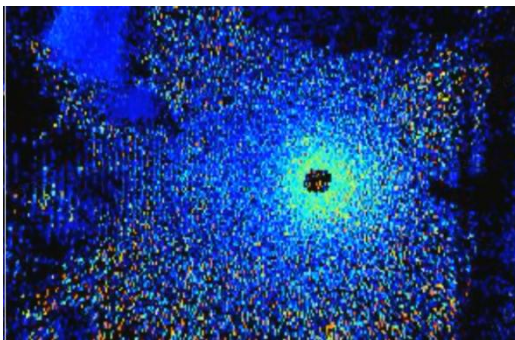

- Outdoor sunlight shining on the over channel will not have an effect, but mirrored reflections that allow sunlight to shine on the ToF Sensor should be avoided.

6.4 Installation

Step 1: Fix the two mounting ears to both side of the device with screws.

Step 2: Drill 4 holes on the ceiling or wall according to the mounting ear's hole and fix the wall plugs into the holes, then fix the device to wall plugs with mounting screws. When installing the device, it's suggested to fix the two screws on the top at first.

You can select the below mounting methods depending on the environment.

Ceiling Mount

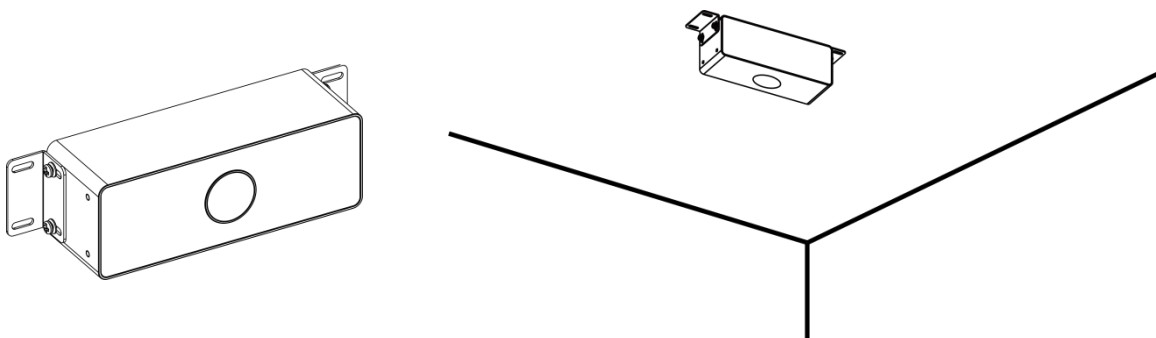

Embedded Mount

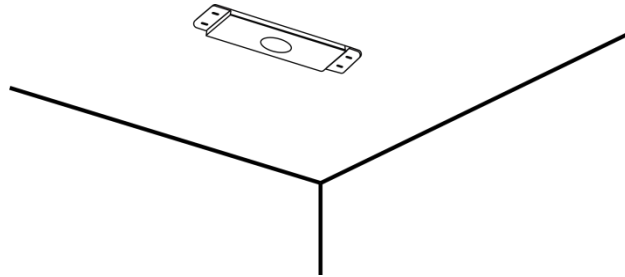
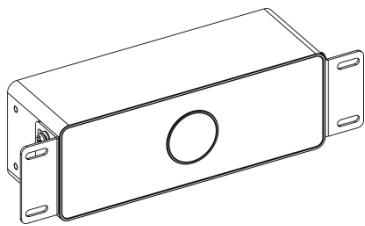

Wall Mount

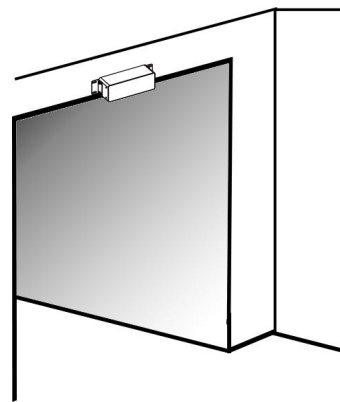
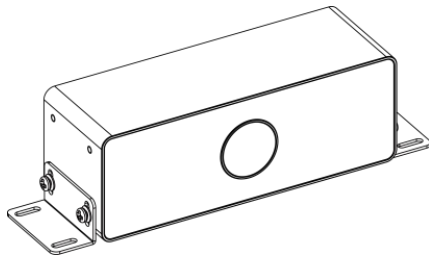

Besides, the device can be mounted with the mounting stand via the threaded hole.

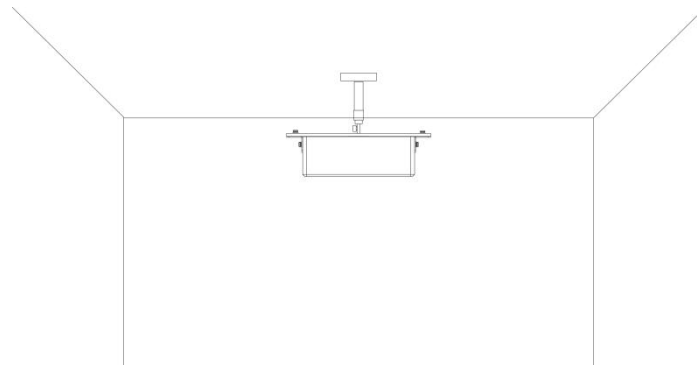

Note:

- Tilt installation should be avoided. Ensure that the front of the device and the ground plane parallel.
- Two devices should be avoided being installed too close since the ToF light from one device will affect count accuracy of the other device. The distance between two devices should be in accordance with the coverage without overlap.

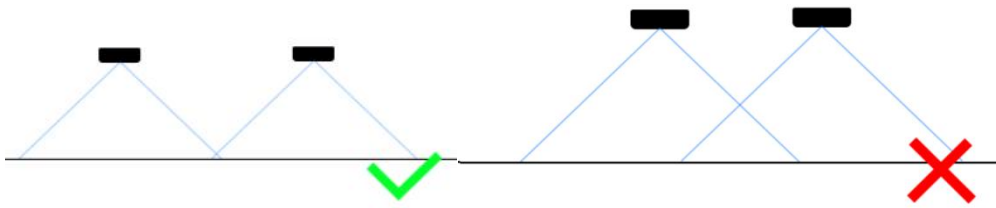

- Avoid installing the device against the wall and ensure the device keep away from the wall at least 20cm. When installed on the door lintel, the device needs to be noted flush with the lower edge of the door frame.

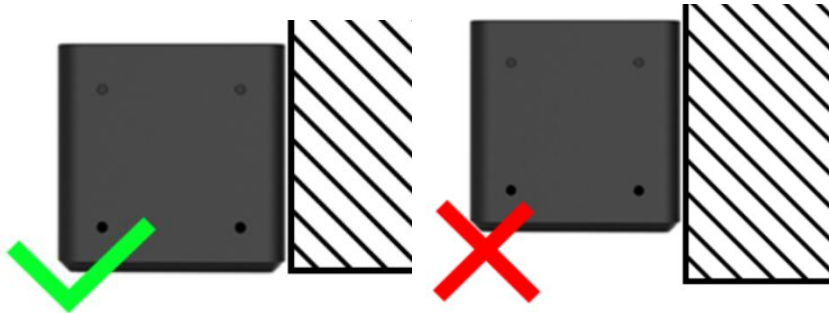

- When you install devices on the top of swinging doors, it is suggested to keep the door normally open. If the door must be normally closed, please install the device on the other side of door to keep away from the door movement. And it is suggested to keep away from the door with a distance of at least 20cm.

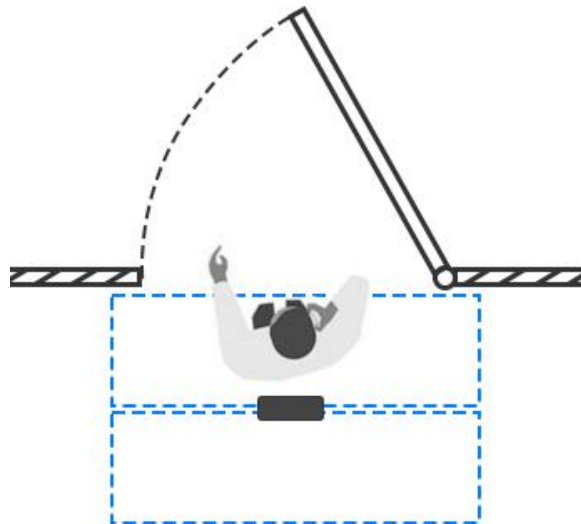

6.5 Factors Affecting Accuracy

- Wearing a fisherman's hat or carrying a cardboard box on the shoulder: The target will not be recognized because it will become unlike a human in depth map.
- Handheld or cart-carrying a humanoid doll with sufficient height to pass by: The doll will be mistakenly detected because it is sufficiently human-like in depth map.

7. Device Payload

All data are based on following format(HEX), the Data field should follow little-endian:

Channel1	Type1	Data1	Channel2	Type2	Data2	Channel 3	...
1 Byte	1 Byte	N Bytes	1 Byte	1 Byte	M Bytes	1 Byte	...

For decoder examples please find files on <https://github.com/Milesight-IoT/SensorDecoders>.

7.1 Uplink Data

VS132 reports basic information of sensor whenever joining the network and the number of people according to settings.

Channel	Type	Description
ff	01 (Protocol Version)	01=> V1
	09 (Hardware Version)	01 04 => V1.4
	16 (Device SN)	16 digits
	1f (Software Version)	1f 07 00 4b => V31.7.0.75
03	d2 (accumulated counter)	Accumulated in counter, 4 bytes
04	d2 (accumulated counter)	Accumulated out counter, 4 bytes
05	cc (Periodic Counter)	Byte 1-2: in counter during the report interval Byte 3-4: out counter during the report interval

Example:

1. Device information

ff0101 ff166600b09409760000 ff090102 ff1f84010001					
Channel	Type	Value	Channel	Type	Value
ff	01 (Protocol Version)	01 (V1)	ff	16(Device SN)	66 00 b0 94 09 76 00 00
Channel	Type	Value	Channel	Type	Value
ff	09 (Hardware version)	0102 (V1.2)	ff	1f (Software version)	84 01 00 01 (V132.1.0.1)

2. People counter

03d205000000 04d203000000 05cc02000100					
Channel	Type	Value	Channel	Type	Value
03	d2	05 00 00 00 =>	04	d2	03 00 00 00

	(accumulated in counter)	00 00 00 05=5		(accumulated out counter)	=> 00 00 00 03=3
Channel	Type	Value			
05	cc (Periodic Counter)	In: 02 00 => 00 02 = 2 Out: 01 00 => 00 01 =1			

7.2 Downlink Command

VS132 supports downlink commands to configure the device. Application port is 85 by default.

Channel	Type	Description
ff	10 (Reboot)	ff (Reserved)
	03 (Reporting Interval)	2 Bytes, unit: s Note: the device will change the interval unit as minutes. For example, if you send 62s, the device will be set as 1 minute.
	04 (Confirm Mode)	00: disable, 01: enable
	05 (LoRaWAN [®] Channel Mask)	Byte 1: Channel index range 01: 0-15 02: 16-31 03: 32-47 04: 48-63 05: 64-79 06: 80-95 Byte 2-3: indicate disable or enable via every bit, 0=disable, 1=enable
	40 (ADR)	00: disable, 01: enable
	41 (Application Port)	1 Byte, default is 85
	42 (Wi-Fi)	00: disable, 01: enable
	43 (People Counting Periodic Report)	00: disable, 01: enable
	51 (Clear the accumulated counting)	ff (Reserved)

Note: After changing any parameter of LoRaWAN[®] setting, the device will re-join the network.

Example:

1. Disable Wi-Fi.

ff4200		
Channel	Type	Value
ff	42 (Wi-Fi)	00: disable

2. Set AU915 or US915 channel mask as 8-15.

ff0501ff00 ff05020000 ff05030000 ff05040000 ff05050000		
Channel	Type	Value
ff	05 (Set Channel Mask)	01: Channel index 0-15, ff00 => 8-15 is enabled 02-05: Channel index 16-79, 0000 => all disabled

3. Reboot the device.

ff10ff		
Channel	Type	Value
ff	10 (Reboot)	ff (Reserved)

4. Set reporting interval as 20 minutes.

ff03b004		
Channel	Type	Value
ff	03(Set Reporting Interval)	b0 04 => 04 b0 = 1200s =20 minutes

-END-